

Please note that the data given here has been taken from the online catalog. For comprehensive information and data, please refer to the user documentation at <http://www.download.phoenixcontact.com>. The General Terms and Conditions of Use apply to Internet downloads.

► Extract from the online catalog

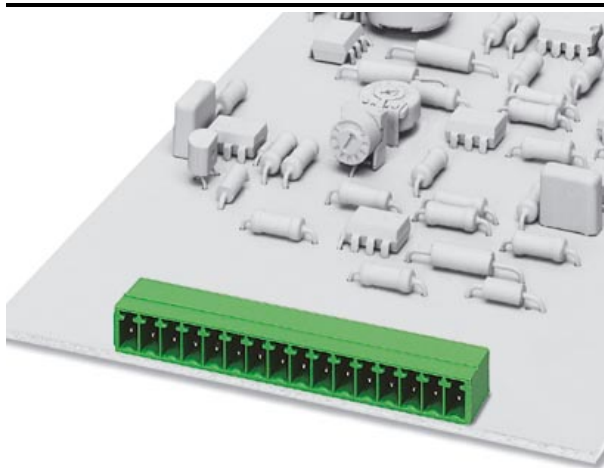

Header, nominal current: 8 A, rated voltage: 160 V, pitch: 3.81 mm, no. of positions: 15, mounting: Soldering

The illustration shows a 16-position version

| | |
|--------------------------|--------------------|
| Order No. | 1803400 |
| Ord designation | MC 1,5/15-G-3,81 |
| EAN | 4017918045715 |
| Pack | 50 Pcs. |
| Customs tariff | 85369010 |
| Catalog page information | Page 108 (CC-2005) |

► Technical data

Dimensions / positions

| | |
|---------------------|--------------|
| Height | 7.7 mm |
| Pitch | 3.81 mm |
| Dimension a | 53.34 mm |
| Number of positions | 15 |
| Pin dimensions | 0,8 x 0,8 mm |
| Hole diameter | 1.2 mm |

Technical data

| | |
|------------------------------------|--------|
| Insulating material group | IIIa |
| Rated surge voltage (III/3) | 2.5 kV |
| Rated surge voltage (III/2) | 2.5 kV |
| Rated surge voltage (II/2) | 2.5 kV |
| Rated voltage (III/2) | 160 V |
| Rated voltage (II/2) | 250 V |
| Connection in acc. with standard | EN-VDE |
| Nominal current I_N | 8 A |
| Nominal voltage U_N | 160 V |
| Maximum load current | 8 A |
| Insulating material | PBT |
| Inflammability class acc. to UL 94 | V0 |

► Certificates

Certificate logos



UL

| | |
|-----------------------|-------|
| Nominal voltage U_N | 300 V |
| Nominal current I_N | 8 A |

CSA

| | |
|-----------------------|-------|
| Nominal voltage U_N | 300 V |
| Nominal current I_N | 8 A |

► Drawings

Drilling diagram

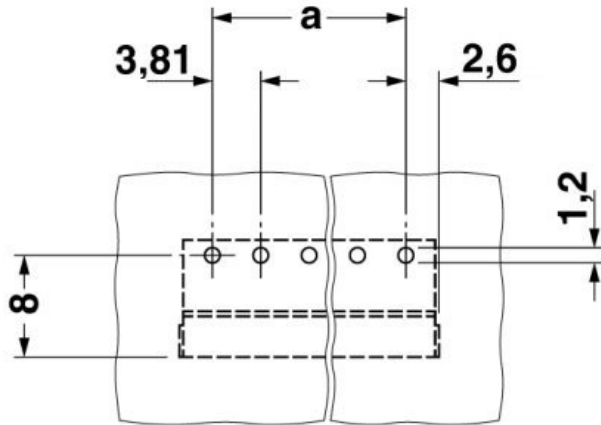

Dimensioned drawing

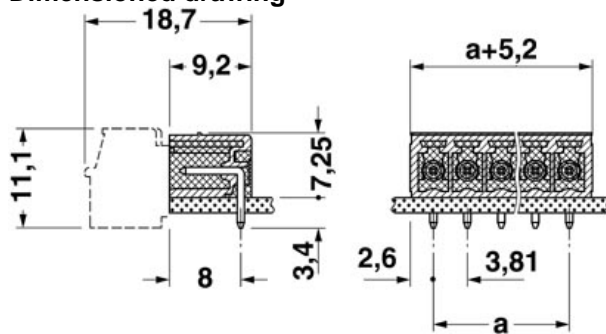

► Accessories

| Item | Designation | Description |
|---------------------|--------------------------|--|
| General | | |
| 1841174 | MC 1,5/10-LWL 1,5-3,81 | MINI-COMBICON optical fibers, pitch 3.81 mm, 10-position, divisible, are snapped into the back of the MC header, color: transparent, dimension a: 1.5 mm |
| 1841190 | MC 1,5/10-LWL 2,3-3,81 | MINI-COMBICON optical fibers, pitch 3.81 mm, 10-position, divisible, are snapped into the back of the MC header, color: transparent, dimension a: 2.3 mm |
| 1841213 | MC 1,5/10-LWL 4-3,81 | MINI-COMBICON optical fibers, pitch 3.81 mm, 10-position, divisible, are snapped into the back of the MC header, color: transparent, dimension a: 4.0 mm |
| Marking | | |
| 1051993 | B-STIFT | Marker pen, for manual labeling of unprinted Zack strips, smear-proof and waterproof, line thickness 0.5 mm |
| 0804109 | SK 3,81/2,8:FORTL.ZAHLEN | Marker card, printed horizontally, self-adhesive, 10-section marker strip, 14 identical decades marked 1-10, 11-20 etc. up to 91-(99)100, sufficient for 140 terminal blocks |
| 0805056 | SK 3,81/2,8:SO | Marker card, special printing, self-adhesive, labeled acc. to customer requirements, 14 identical marker strips per card, max. 25-position labeling per strip. |
| Plug/Adapter | | |
| 1734634 | CP-MSTB | Coding section, is inserted into the slot on the plug or inverted header, red insulating material |

► Additional products

| Item | Designation | Description |
|----------------|-------------------------|--|
| General | | |
| 1851177 | FK-MCP 1,5/15-ST-3,81 | Plug component, nominal current: 8 A, rated voltage: 160 V, pitch: 3.81 mm, no. of positions: 15, type of connection: Spring-cage connection |
| 1850796 | FRONT-MC 1,5/15-ST-3,81 | Plug component, nominal current: 8 A, rated voltage: 160 V, pitch: 3.81 mm, no. of positions: 15, type of connection: Screw connection |
| 1862700 | IMC 1,5/15-G-3,81 | Header, nominal current: 8 A, rated voltage: 160 V, pitch: 3.81 mm, no. of positions: 15, mounting: Soldering |
| 1875551 | IMCV 1,5/15-G-3,81 | Header, nominal current: 8 A, rated voltage: 160 V, pitch: 3.81 mm, no. of positions: 15, mounting: Soldering |
| 1803701 | MC 1,5/15-ST-3,81 | Plug component, nominal current: 8 A, rated voltage: 160 V, pitch: 3.81 mm, no. of positions: 15, type of connection: Screw connection |
| 1852309 | MCC 1/15-STZ-3,81 | Plug component, nominal current: 8 A, rated voltage: 160 V, pitch: 3.81 mm, no. of positions: 15, type of connection: Crimp connection |
| 1827253 | MCVR 1,5/15-ST-3,81 | Plug component, nominal current: 8 A, rated voltage: 160 V, pitch: 3.81 mm, no. of positions: 15, type of connection: Screw connection |
| 1827101 | MCVW 1,5/15-ST-3,81 | Plug component, nominal current: 8 A, rated voltage: 160 V, pitch: 3.81 mm, no. of positions: 15, type of connection: Screw connection |
| 1897526 | QC 0,5/15-ST-3,81 | Plug component, nominal current: 8 A, rated voltage: 160 V, pitch: 3.81 mm, no. of positions: 15, type of connection: Insulation displacement connection QUICKON |

► Address

PHOENIX CONTACT Inc., USA
586 Fulling Mill Road
Middletown, PA 17057
USA
Phone (800) 888-7388
Fax (717) 944-1625
<http://www.phoenixcon.com>
Phoenix Contact
Technical modifications reserved;